

Data Sheet



Article number: 20883005A

Description: E+G
Spring plunger GN 614-8-KD

Measures

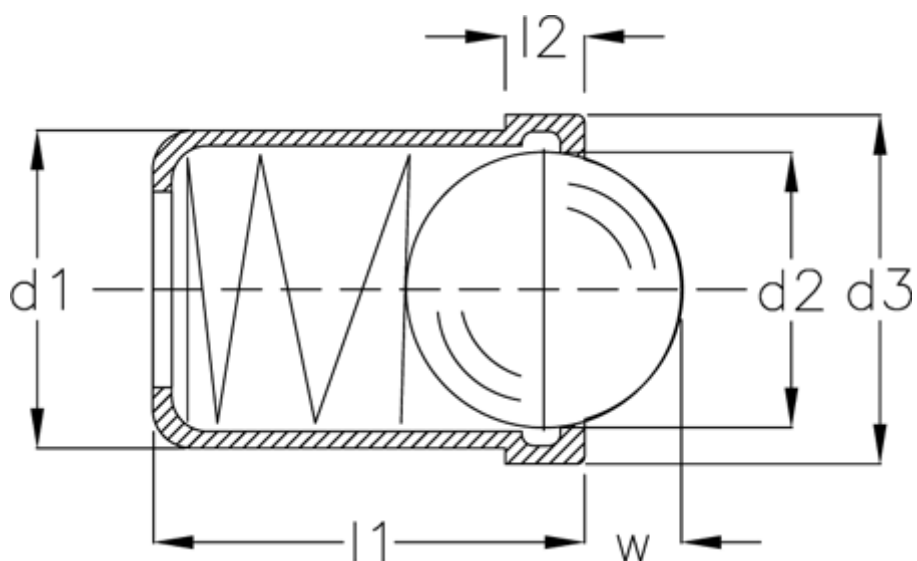

d1	= 8
d2	= 6.5
d3	= 8.5
l1	= 9.0
l2	= 1.0
Spring pressure N bottom	= 18.0
Spring pressure N top	= 8.0
W	= 1.9